



Installation Instructions

Instructions d'installation
Installationsanweisungen
Instrucciones de instalación
Istruzioni per l'installazione
Installatie-instructies
インストール手順
安装指南
إرشادات التركيب

 Devices must be installed in an approved enclosure by a qualified electrician in accordance with all national and local electrical and construction codes and regulations.

Les appareils doivent être installés dans un lieu jugé apte, par un électricien qualifié et conformément aux règles et normes locales et nationales en matière d'électricité et de construction.

Die Geräte müssen von einem geprüften Elektriker entsprechend allen nationalen und lokalen Elektro- und Bauvorschriften in einem zugelassenen Gehäuse installiert werden.

Los dispositivos se deben instalar en un recinto aprobado por un electricista cualificado de acuerdo a todos los reglamentos eléctricos y de construcción locales y nacionales pertinentes.

I dispositivi devono essere installati da un elettricista qualificato in un luogo approvato, in conformità a tutti gli standard e le norme nazionali e locali vigenti in materia di impianti elettrici e costruzioni edilizie.

Apparaten moeten door een erkende elektricien worden geïnstalleerd in een goedgekeurde behuizing in overeenstemming met alle nationale en lokale elektriciteits- en bouwvoorschriften en wetgeving.



デバイスを取り付ける際は、資格のある電気技師に依頼し、電気と建設に関する国および地域のすべての法令に従って、認可されている筐体内に取り付けてください。

根据国家/地区及当地的电气与建筑规范和法规，该设备必须由有资质的电工安装在经批准的外罩内。

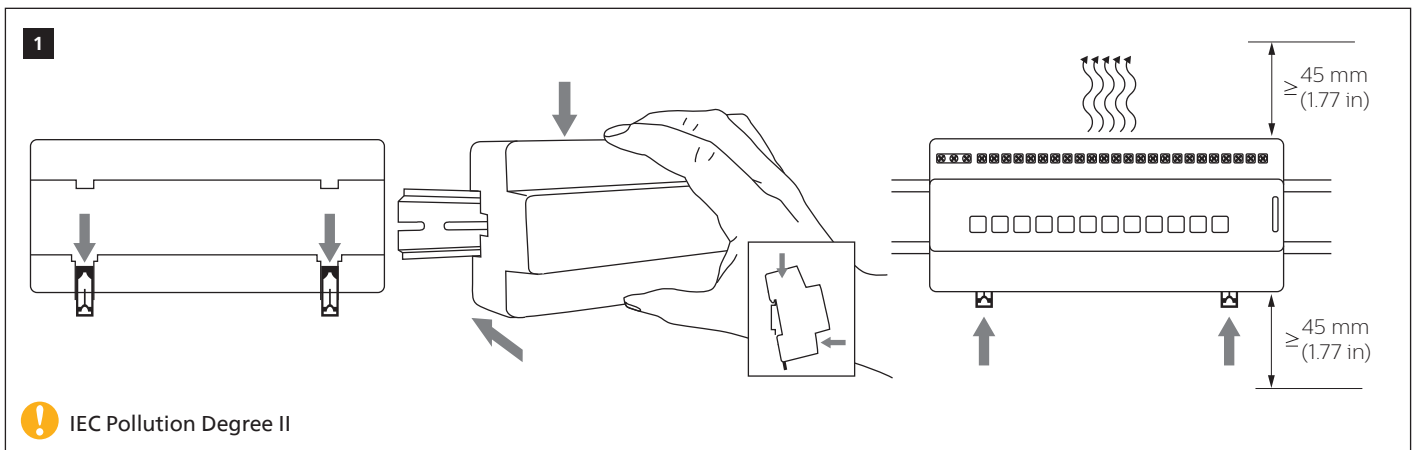
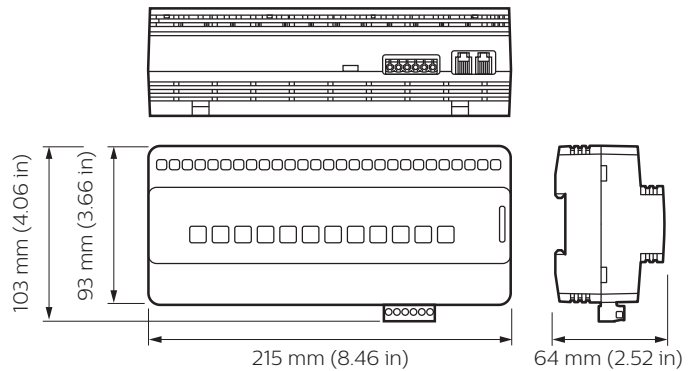
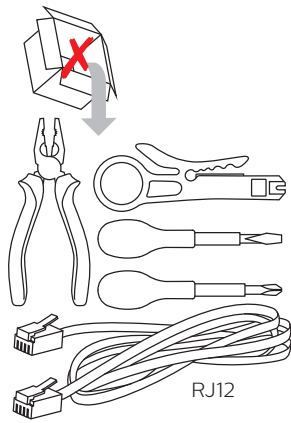
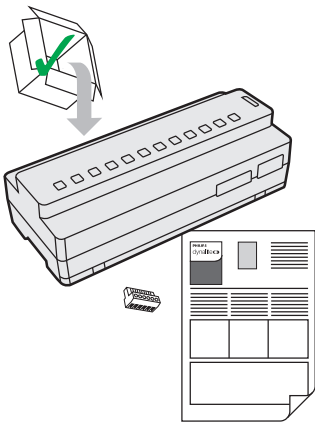
يلزم تركيب الأجهزة داخل حاوية معتمدة، من قبل كهربائي مؤهل وفقاً لجميع قوانين ولوائح الكهرباء والإنشاءات الوطنية والمحلية

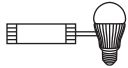

Control Channel Ratings

		
DALI Broad-cast	$\leq 80/\text{CH}$ Guaranteed 160 mA Maximum 250 mA Insulation: basic	≤ 300
DSI	$\leq 80/\text{CH}$	≤ 300
0-10 V	Sink 50 mA Source 50 mA	Driver dependent

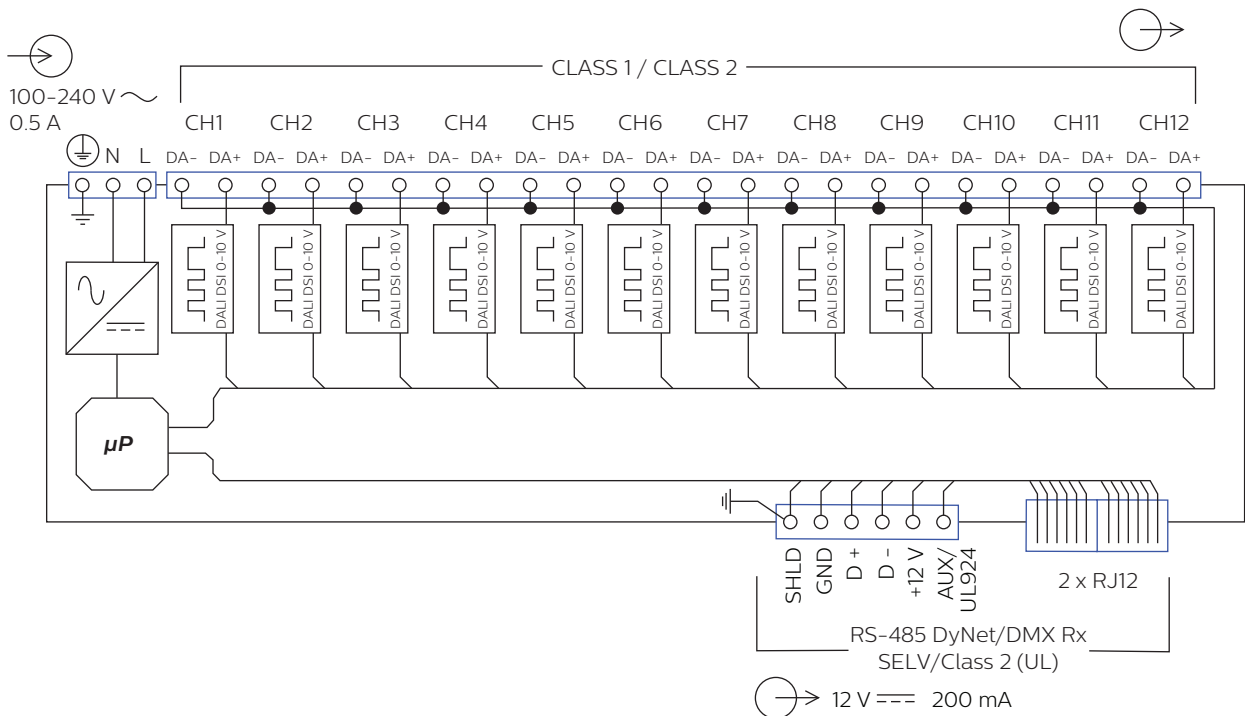
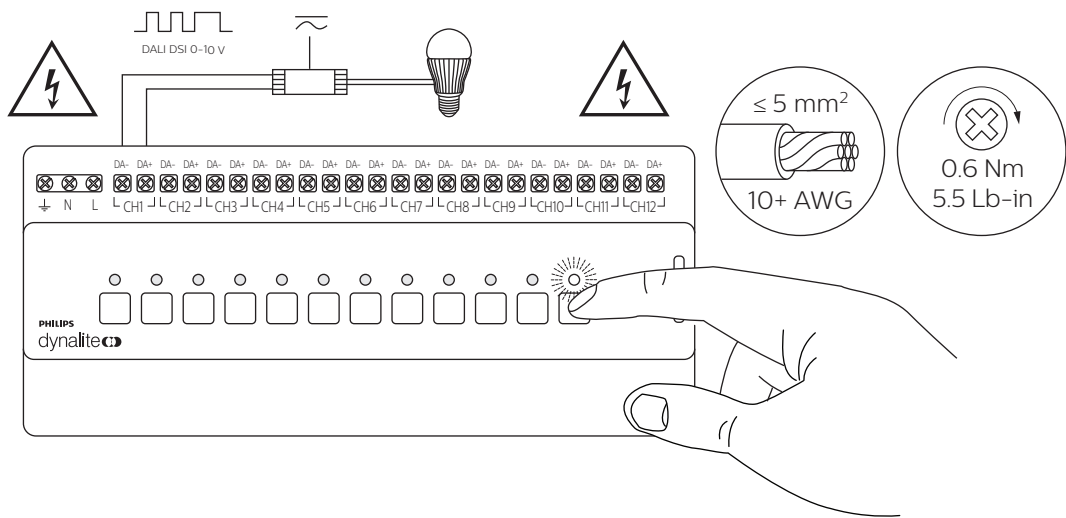

 IEC Overvoltage Category III

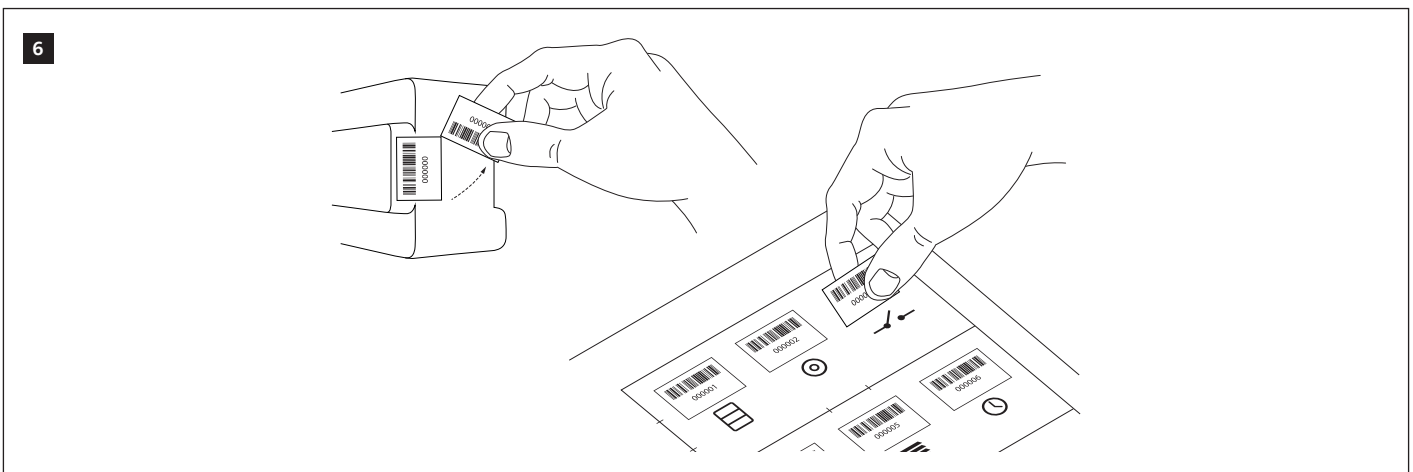
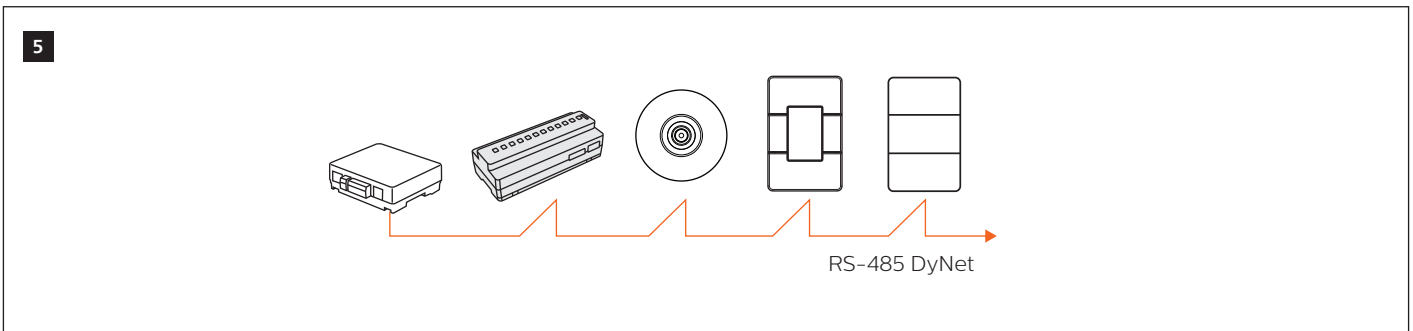
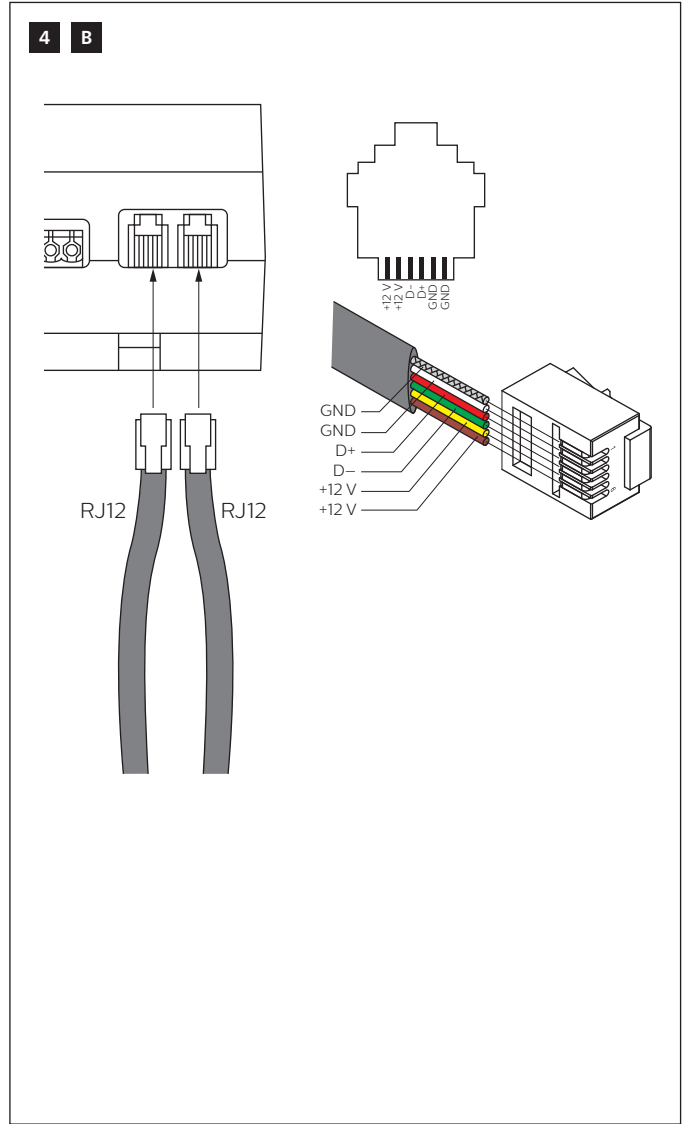
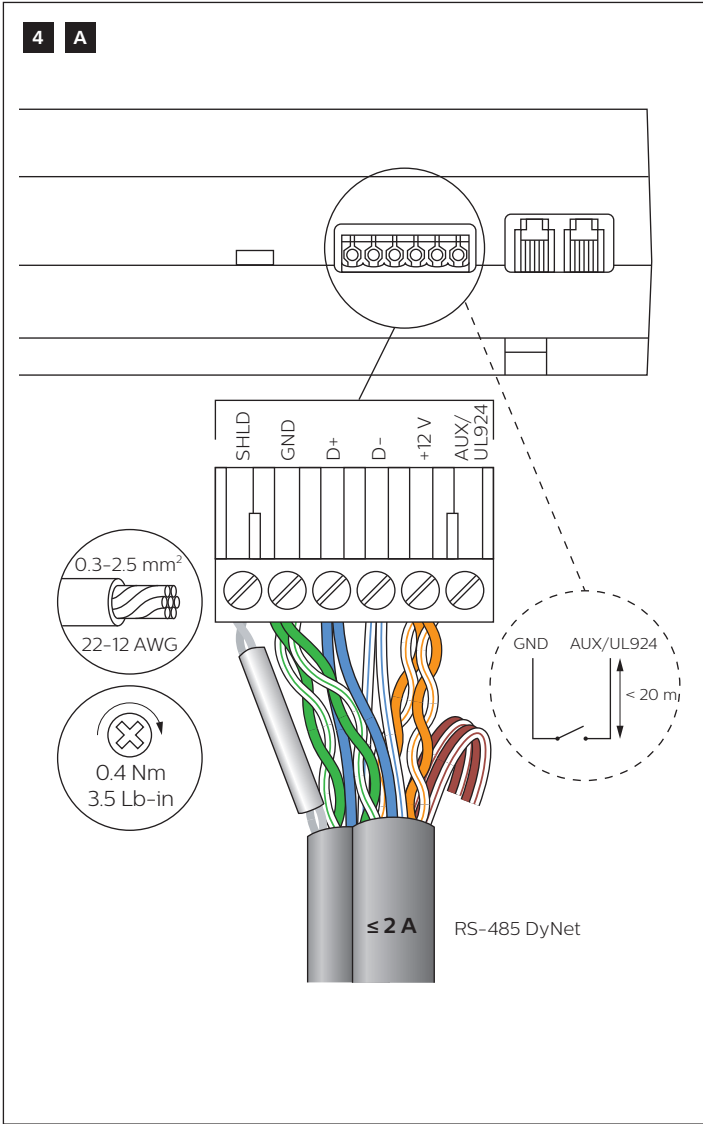

⚠ This is a Class A product. In a domestic environment this product may cause radio interference, in which case the user may be required to take adequate measures.

📡 **Federal Communications Commission (FCC) Compliance Notice: Radio Frequency Notice** – This equipment has been tested and found to comply with the limits for a Class A digital device, pursuant to part 15 of the FCC Rules. These limits are designed to provide reasonable protection against harmful interference when the equipment is operated in a commercial environment. This equipment generates, uses, and can radiate radio frequency energy and, if not installed and used in accordance with the instruction manual, may cause harmful interference to radio communications. Operation of this equipment in a residential area is likely to cause harmful interference in which case the user will be required to correct the interference at his own expense.

📡 This Class A digital apparatus complies with Canadian ICES-003: CAN ICES-3 (A)/NMB-3(A).

© 2023 Signify Holding. All rights reserved. Specifications are subject to change without notice. No representation or warranty as to the accuracy or completeness of the information included herein is given and any liability for any action in reliance thereon is disclaimed. Philips and the Philips Shield Emblem are registered trademarks of Koninklijke Philips N.V. All other trademarks are owned by Signify Holding or their respective owners.

